



# Model: TC282S

## Soft Serve Freezer Single Flavor, Table Top



Offer all the popular soft serve variations from low or non-fat ice creams to custards, yogurt and sorbet.



### Pre-cooling System

Dual pre-cooling in both freezing cylinder (one, 1.5 liter) and hopper (one, 6.5 liter).



### Standby/Overnight

During long no-use periods, the standby feature maintains safe product temperatures in the mix hopper and freezing cylinder.



### Agitator/Hopper Mixer

Agitator function in hopper keeps mix from separation over time.



### Indicator Lights

The Mix Low light alerts the operator to add mix.



### Counter Function

The numbers on display board shows the dispensed quantity everyday.



### Hardness Adjustable

Hardness is adjustable according to different kinds of mix.



# TC282S Soft Serve Freezer

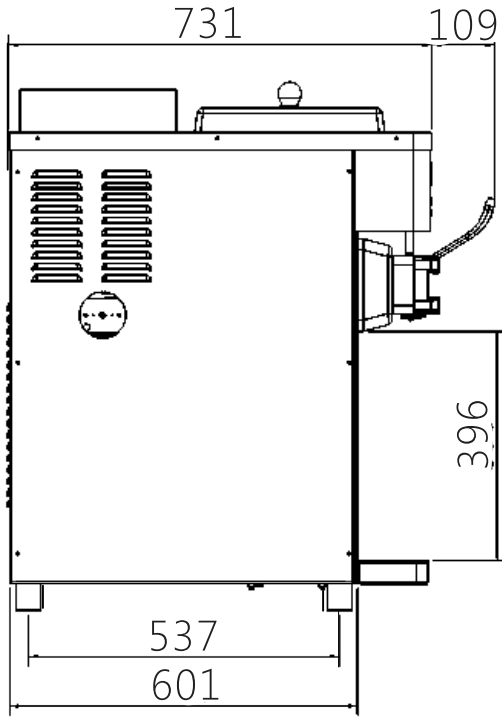
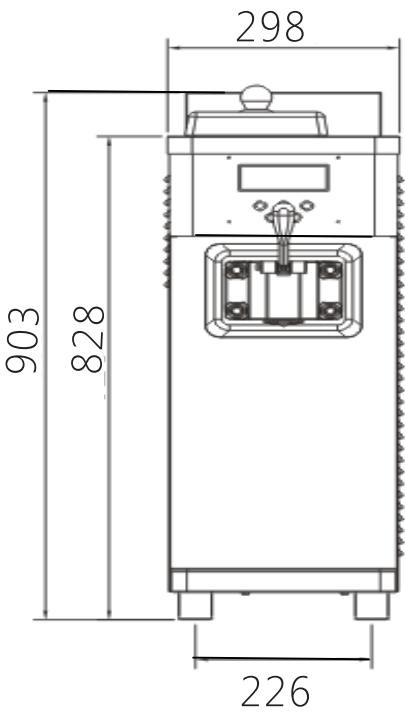

## Weights

	kgs.
Net	105
Crated	124

## Volume

	cu.m.
Volume	0.20

## Dimensions







	mm.
Width	298
Depth	731
Height	903

## Power Supply

Phase	1~
Volt	220V
Hertz	50/60
Power	1750

For exact electrical information, always refer to the data label of the unit.







## Selling Point

-  **50dB** Low Noise Tech
-  Keep Fresh Tech
-  Frequency Converter Tech
-  Defrost Tech
-  Higher Efficient Refrigeration Tech
-  Low-energy-consuming Tech
-  Perfect Continuity of Dispensing Tech





### Unique Features

- Advanced Gear Pump System 
- Counter 
- Smart Pre-cooling 
- Overnight 
- Low Mix Alarm 
- 6-level Hardness Adjustable 
- Error Code Indication 

The latest designed pump feeding commercial mini-ice cream machine for soft-serve ice cream. Do you always feel annoyed about the ice cream mixture spurting problem from the pump? Don't have much space available for setting up new equipment? Does your demand vary according to season and type of clients? Then Taycool TC302A is the answer. Its technological design and the attention to the smallest detail make TC302A the perfect choice for furnishing your ice cream business.



### General Parameters

Model	TC302A	Installation	Countertop
Capacity	240cones/H(80g/cone)	Flavor	1
Hopper/Quantity	14L/1	Cylinder/Quantity	2L/1
Net Weight	110KG	Gross Weight	140KG
Product Dimension	323x781x866 mm	Packing Dimension	435x890x1060 mm

Note: The capacity depends on the operating environment and mixture.

### Electrical Specification

Rated Power	1850W	Voltage/Frequency	220V/50Hz/60Hz
Motor/Quantity	750W/1	Suggested Power Supply	16A

### Refrigeration System

Compressor/Quantity	Tecumseh 1HP/1	Refrigerating Capacity	4071 BTU/H
Refrigerant	R404a	Cooling System	Air Cooling

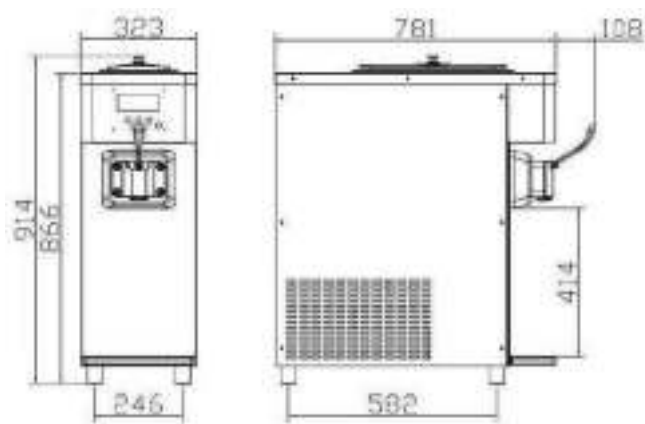

Taycool is never satisfied with a good machine, but the state of perfection.



- Advanced pump system prepare lighter weight, higher overrun, better texture ice cream. Every piece of tiny pump parts are so precisely and accurately to ensure every detail fits perfectly.

- Perfect continuity of dispensing technology, creates a smooth, creamy ice cream that replicates the consistency of soft serve.

- Integrated frequency converter reduce energy consumption and noise.

- Polished nuts and transparent discharge door highlight the style of your stores.







- Tecumseh compressor and other components from named producers ensure high performance and long durability.





### Unique Features



- Automatic Dispensing 
- Counter 
- Smart Pre-cooling 
- Overnight 
- Low Level Alarm 
- 6-level Hardness Adjustable 
- Error Code Indication 

- Labor-saving
- Set-volume Dispensing
- Cloud Management
- Perfect Choice for Large Chain Business



## General Parameters

Model	TC302D	Installation	Countertop
Capacity	180cones/H(80g/cone)	Flavor	1
Hopper/Quantity	14L/1	Cylinder/Quantity	2L/1
Net Weight	110KG	Gross Weight	140KG
Product Dimension	323x811x865 mm	Packing Dimension	430x870x1020 mm

Note: The capacity depends on the operating environment and mixture.

## Electrical Specification

Rated Power	1850W	Voltage/Frequency	220V/50Hz/60Hz
Motor/Quantity	750W/1	Suggested Power Supply	16A

## Refrigeration System

Compressor/Quantity	Tecumseh 1HP/1	Refrigerating Capacity	4071 BTU/H
Refrigerant	R404a	Cooling System	Air Cooling

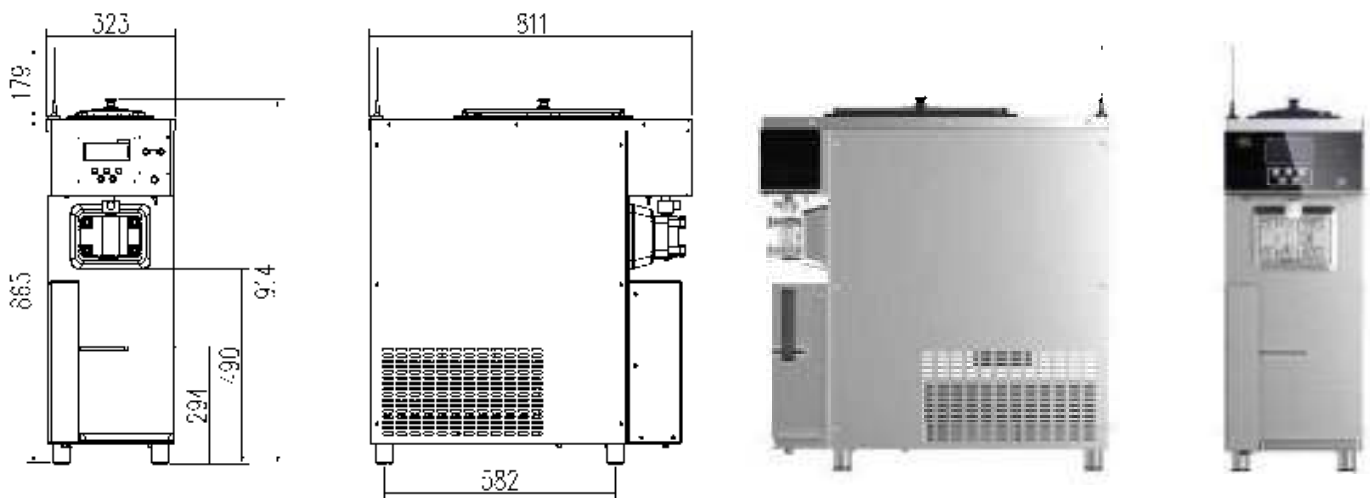

Taycool is never satisfied with a good machine, but the state of perfection.



- Advanced hopper mixing system prepare lighter weight, higher overrun, better texture ice cream. Every piece of tiny parts are so precisely and accurately to ensure every detail fits perfectly.



- Perfect continuity of dispensing technology, creates a smooth, creamy ice cream that replicates the consistency of soft serve.



- Integrated frequency converter reduce energy consumption and noise.



- Polished nuts and transparent discharge door highlight the style of your stores.



- Tecumseh compressor and other components from named producers ensure high performance and long durability.



### Unique Features



Heat Treatment Function 

Counter 

Smart Pre-cooling 

Overnight 

Low Mix Alarm 

6-level Hardness Adjustable 

Error Code Indication 

High-spec heat treatment for professional clients.  
 New gen of pasteurization system offers cream mix  
 2-hour sauna and quickly cools it down.  
 Sterilizes of 97%~99% bacteria to achieve long-term  
 fresh preservation before cleaning.



## General Parameters

Model	TC302P	Installation	Countertop
Capacity	180cones/H(80g/cone)	Flavor	1
Hopper/Quantity	14L/1	Cylinder/Quantity	2L/1
Net Weight	140KG	Gross Weight	175KG
Product Dimension	380x810x976 MM	Packing Dimension	490x920x1180 MM

Note: The capacity depends on the operating environment and mixture.

## Electrical Specification

Rated Power	1750W	Voltage/Frequency	220V/50Hz/60Hz
Motor/Quantity	750W/1	Suggested Power Supply	16A

## Refrigeration System

Compressor/Quantity	Tecumseh 1HP/1	Refrigerating Capacity	4071 BTU/H
Refrigerant	R404a	Cooling System	Air Cooling

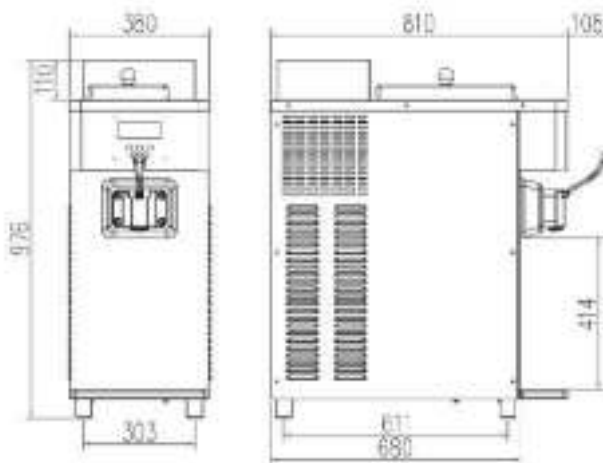

Taycool is never satisfied with a good machine, but the state of perfection.



- Advanced mixing system in hopper, prepare lighter weight, higher overrun, better texture ice cream. Every piece of tiny parts are so precisely and accurately to ensure every detail fits perfectly.



- Perfect continuity of dispensing technology, creates a smooth, creamy ice cream that replicates the consistency of soft serve.



- Integrated frequency converter reduce energy consumption and noise.



- Polished nuts and transparent discharge door highlight the style of your stores.



- Tecumseh compressor and other components from named producers ensure high performance and long durability.











A stunning modern design



### Unique Features

- Counter 
- Smart Pre-cooling 
- Overnight 
- Low Mix Alarm 
- 6-level Hardness Adjustable 
- Error Code Indication 

The latest designed gravity feeding commercial mini-ice cream machine for soft serve, frozen yogurt. Do you always feel annoyed when the machine makes much noisy while running? Don't have much space available for setting up new equipment? Does your demand vary according to season and type of clients? Then Taycool TC302S is the answer. Its technological design and the attention to the smallest detail make TC302S the perfect choice for furnishing your ice cream business.



## General Parameters

Model	TC302S	Installation	Countertop
Capacity	180cones/H(80g/cone)	Flavor	1
Hopper/Quantity	12L/1	Cylinder/Quantity	2L/1
Net Weight	104KG	Gross Weight	134KG
Product Dimension	323x781x866 mm	Packing Dimension	435x890x1060 mm

Note: The capacity depends on the operating environment and mixture.

## Electrical Specification

Rated Power	1750W	Voltage/Frequency	220V/50Hz/60Hz
Motor/Quantity	750W/1	Suggested Power Supply	16A

## Refrigeration System

Compressor/Quantity	Tecumseh 1HP/1	Refrigerating Capacity	4071 BTU/H
Refrigerant	R404a	Cooling System	Air Cooling

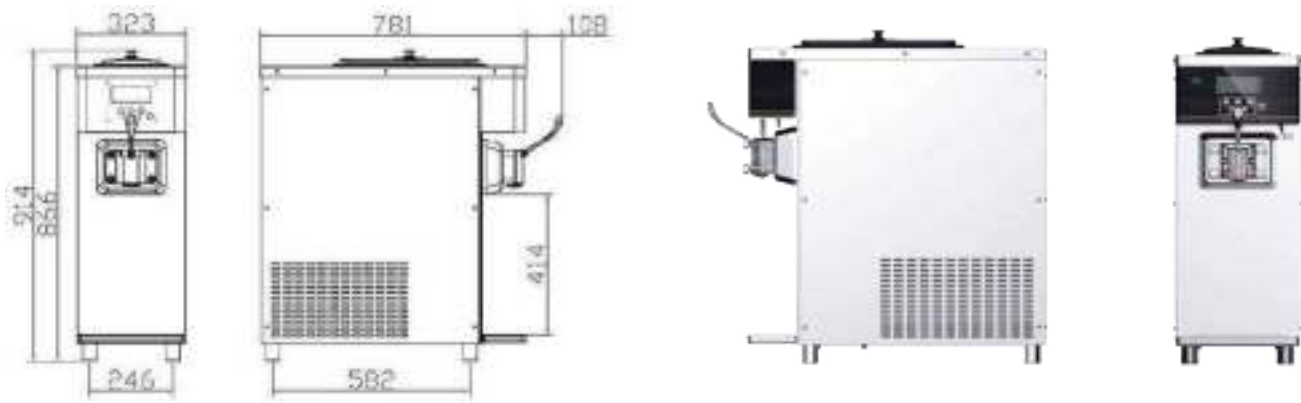

Taycool is never satisfied with a good machine, but the state of perfection.



- Advanced mixing system in hopper, prepare lighter weight, higher overrun, better texture ice cream. Every piece of tiny parts are so precisely and accurately to ensure every detail fits perfectly.

- Perfect continuity of dispensing technology, creates a smooth, creamy ice cream that replicates the consistency of soft serve.







- Integrated frequency converter reduce energy consumption and noise.

- Polished nuts and transparent discharge door highlight the style of your stores.

- Tecumseh compressor and other components from named producers ensure high performance and long durability.



### Unique Features

- Agitator/Hopper Mixing System 
- Counter 
- Smart Pre-cooling 
- Overnight 
- Low Mix Alarm 
- 6-level Hardness Adjustable 
- Error Code Indication 

Italian style elegant design, application of high-tech core technology to meet customer's diversity demands, Taycool TC322S bring you awesome experience.

Equipped with Taycool's patented core control system, intuitive touchable LCD screen, touching slightly the five independent buttons to produce a variety of flavors for one-step: classic milk flavor, chocolate vanilla flavor, frozen yogurt, tropical fruits flavors, cafe flavor. With the newest long-time keeping fresh function and frequency mute function, enjoy making delicious ice cream quietly.



## General Parameters

Model	TC322S	Installation	Countertop
Capacity	300cones/H(80g/cone)	Flavor	2+Twist
Hopper/Quantity	14L/2	Cylinder/Quantity	2L/2
Net Weight	140KG	Gross Weight	180KG
Product Dimension	540x732x953 mm	Packing Dimension	660x860x1210 mm

Note: The capacity depends on the operating environment and mixture.

## Electrical Specification

Rated Power	2500W	Voltage/Frequency	220V/50Hz/60Hz
Motor/Quantity	1100W/1	Suggested Power Supply	20A

## Refrigeration System

Compressor/Quantity	Tecumseh 1.5HP/1	Refrigerating Capacity	5473 BTU/H
Refrigerant	R404a	Cooling System	Air Cooling

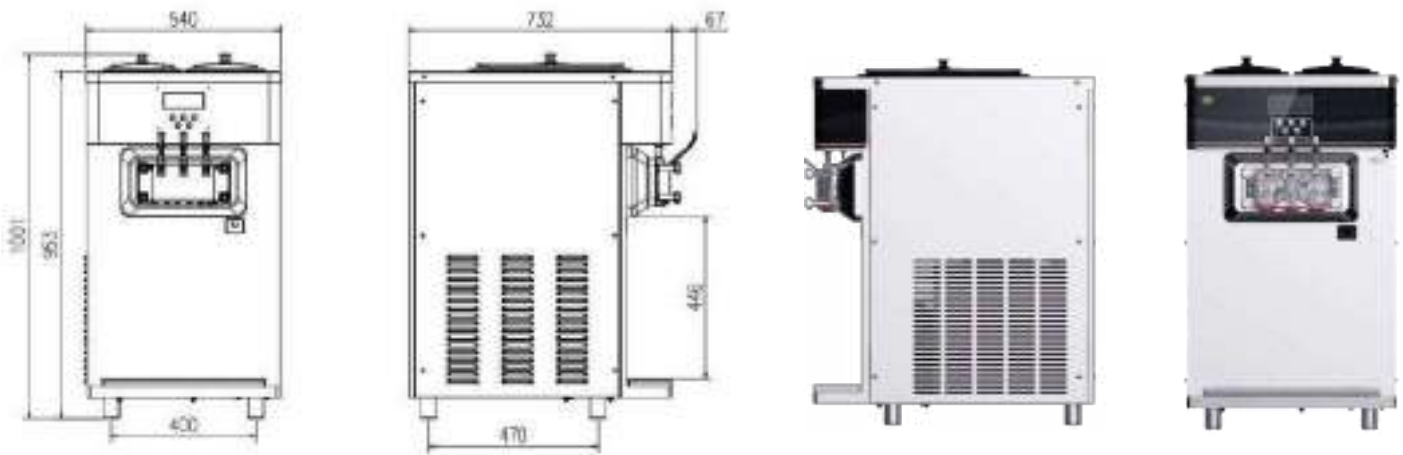

Taycool is never satisfied with a good machine, but the state of perfection.



- Advanced hopper mixing system prepare lighter weight, higher overrun, better texture ice cream. Every piece of tiny parts are so precisely and accurately to ensure every detail fits perfectly.



- Perfect continuity of dispensing technology, creates a smooth, creamy ice cream that replicates the consistency of soft serve.



- Integrated frequency converter reduce energy consumption and noise.









- Polished nuts and transparent discharge door highlight the style of your stores.



- Tecumseh compressor and other components from named producers ensure high performance and long durability.



### Unique Features

- Agitator/Hopper Mixing System 
- Counter 
- Smart Pre-cooling 
- Overnight 
- Low Mix Alarm 
- 6-level Hardness Adjustable 
- Error Code Indication 

Super huge capacity series, application of high-tech core technology to meet customer's diversity demands, Taycool TC392S bring you awesome experience.

Equipped with Taycool's patented core control system, intuitive touchable LCD screen, One-step to make creamy soft serve and frozen yogurt, Perfect continuity of dispensing, it can dispense more than 40 cones one time. With the newest long-time keeping fresh function and frequency mute function, enjoy making delicious ice cream quietly.



## General Parameters

Model	TC392S	Installation	Standing
Capacity	400cones/H(80g/cone)	Flavor	2+Twist
Hopper/Quantity	14L/2	Cylinder/Quantity	2L/2
Net Weight	175KG	Gross Weight	225KG
Product Dimension	540x832x1458 mm	Packing Dimension	650x940x1680 mm

Note: The capacity depends on the operating environment and mixture.

## Electrical Specification

Rated Power	2500W	Voltage/Frequency	220V/50Hz/60Hz
Motor/Quantity	1100W/1	Suggested Power Supply	20A

## Refrigeration System

Compressor/Quantity	Tecumseh 1.5HP/1	Refrigerating Capacity	5473 BTU/H
Refrigerant	R404a	Cooling System	Air Cooling

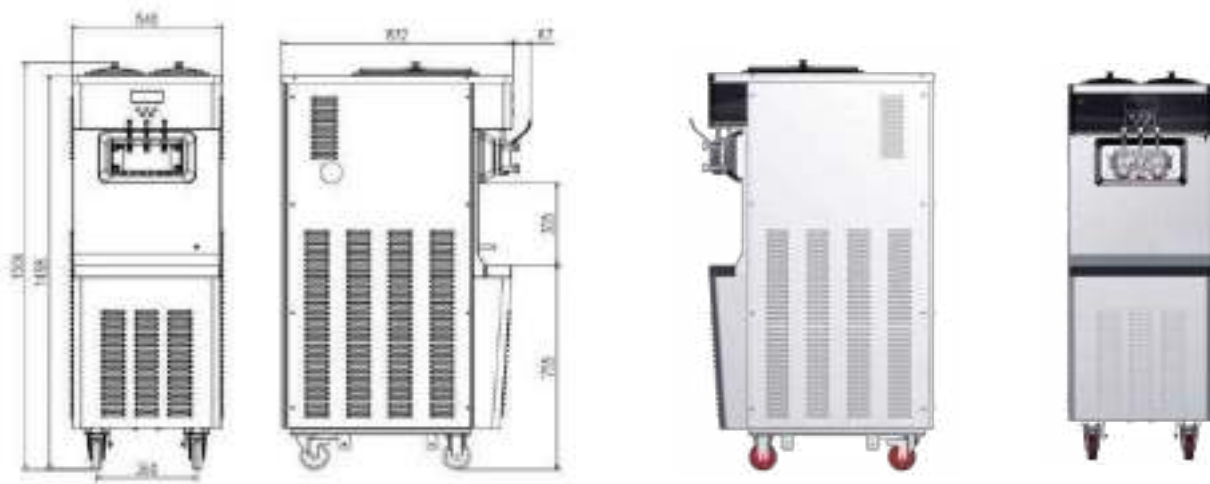

Taycool is never satisfied with a good machine, but the state of perfection.



- Advanced hopper mixing system prepare lighter weight, higher overrun, better texture ice cream. Every piece of tiny parts are so precisely and accurately to ensure every detail fits perfectly.



- Perfect continuity of dispensing technology, creates a smooth, creamy ice cream that replicates the consistency of soft serve.



- Integrated frequency converter reduce energy consumption and noise.



- Polished nuts and transparent discharge door highlight the style of your stores.



- Tecumseh compressor and other components from named producers ensure high performance and long durability.



# Model: TC482S

## Soft Serve Freezer Twin Twist, Table Top Dual Control System



Offer all the popular soft serve variations from low or non-fat ice creams to custards, yogurt and sorbet.



### Pre-cooling System

Dual pre-cooling in both freezing cylinders (two, 2.0 liter) and hoppers (two, 14.0 liter).



### Standby/Overnight

During long no-use periods, the standby feature maintains safe product temperatures in the mix hopper and freezing cylinder.



### Agitator/Hopper Mixer

Agitator function in hopper keeps mix from separation over time.



### Indicator Lights

The Mix Low light alerts the operator to add mix.



### Counter Function

The numbers on display board shows the dispensed quantity everyday.



### Hardness Adjustable

Hardness is adjustable according to different kinds of mix.



# TC482S Soft Serve Freezer

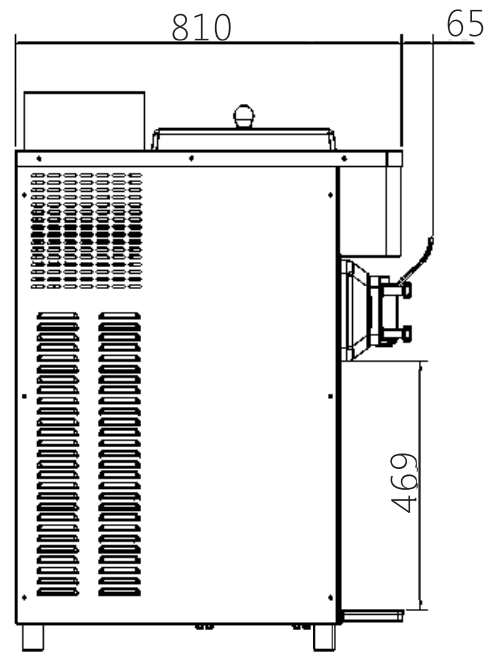
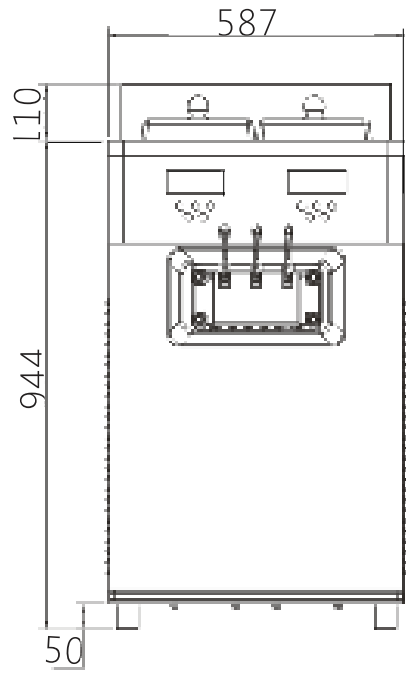

## Weights kgs.

Net 190

Crated 210

## cu.m.

Volume 0.50

## Dimensions mm.

Width 587

Depth 810

Height 1054

## Power Supply

Phase 1~

Volt 220V

Hertz 50/60

Power

For exact electrical information, always refer to the data label of the unit.

## Selling Point



Low Noise Tech



Keep Fresh Tech



Frequency Converter Tech



Defrost Tech



Higher Efficient Refrigeration Tech



Low-energy-consuming Tech









Perfect Continuity of Dispensing Tech







### Unique Features

- Advanced Gear Pump System 
- Counter 
- Smart Pre-cooling 
- Overnight 
- Low Mix Alarm 
- 6-level Hardness Adjustable 
- Error Code Indication 

The latest designed pump feeding commercial huge output ice cream machine for soft-serve ice cream. No need to worry about the ice cream mixture spurting problem from the gear pump when preparing ice cream or frozen yogurt. Simple and modern style of stainless steel shell adds aesthetic value to your bar.



## General Parameters

Model	TC582A	Installation	Standing
Capacity	600cones/H(80g/cone)	Flavor	2+Twist
Hopper/Quantity	14L/2	Cylinder/Quantity	2L/2
Net Weight	235KG	Gross Weight	285KG
Product Dimension	540x832x1458 mm	Packing Dimension	650x940x1680 mm

Note: The capacity depends on the operating environment and mixture.

## Electrical Specification

Rated Power	4300W	Voltage/Frequency	220V/50Hz/60Hz
Motor/Quantity	750W/2	Suggested Power Supply	25A

## Refrigeration System

Compressor/Quantity	Tecumseh 1.5HP/2	Refrigerating Capacity	5473x2 BTU/H
Refrigerant	R404a	Cooling System	Air Cooling

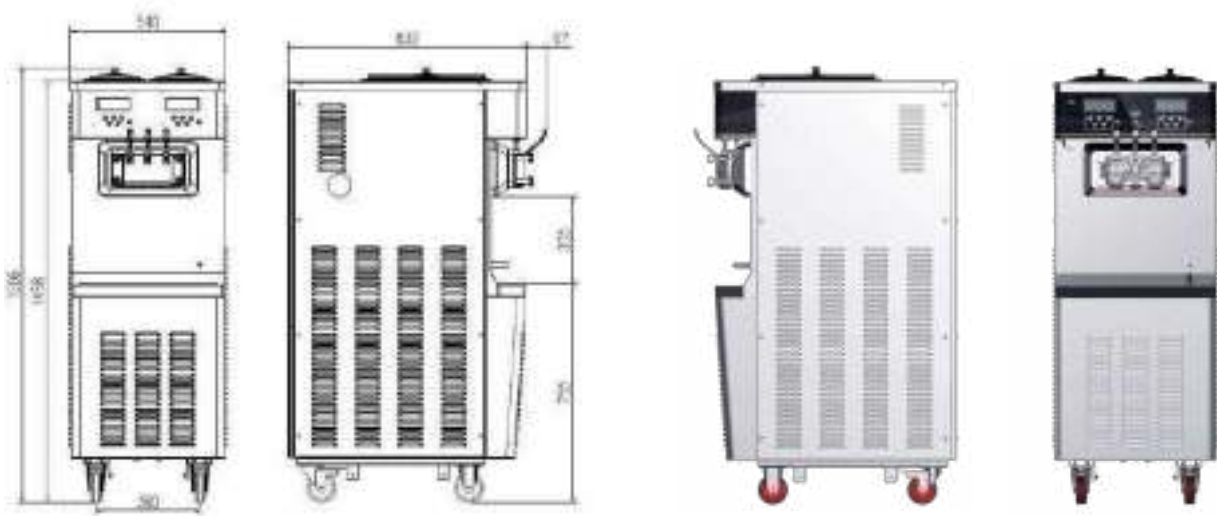

Taycool is never satisfied with a good machine, but the state of perfection.



- Advanced pump system prepare lighter weight, higher overrun, better texture ice cream. Every piece of tiny pump parts are so precisely and accurately to ensure every detail fits perfectly.



- Perfect continuity of dispensing technology, creates a smooth, creamy ice cream that replicates the consistency of soft serve.



- Integrated frequency converter reduce energy consumption and noise.









- Polished nuts and transparent discharge door highlight the style of your stores.



- Tecumseh compressor and other components from named producers ensure high performance and long durability.



### Unique Features

- Heat Treatment Function 
- Counter 
- Smart Pre-cooling 
- Overnight 
- Low Mix Alarm 
- 6-level Hardness Adjustable 
- Error Code Indication 

High-spec heat treatment for professional clients.  
 New gen of pasteurization system offers cream mix  
 2-hour sauna and quickly cools it down.  
 Sterilizes of 97%~99% bacteria to achieve long-term  
 fresh preservation before cleaning.



## General Parameters

Model	TC582P	Installation	Floor Stand
Capacity	500cones/H(80g/cone)	Flavor	2+1
Hopper/Quantity	14L/2	Cylinder/Quantity	2L/2
Net Weight	250KG	Gross Weight	300KG
Product Dimension	540x832x1458 MM	Packing Dimension	650x940x1680 MM

Note: The capacity depends on the operating environment and mixture.

## Electrical Specification

Rated Power	4000W	Voltage/Frequency	220V/50Hz/60Hz
Motor/Quantity	750W/2	Suggested Power Supply	25A

## Refrigeration System

Compressor/Quantity	Tecumseh 1.5HP/2	Refrigerating Capacity	5473x2 BTU/H
Refrigerant	R404a	Cooling System	Air Cooling

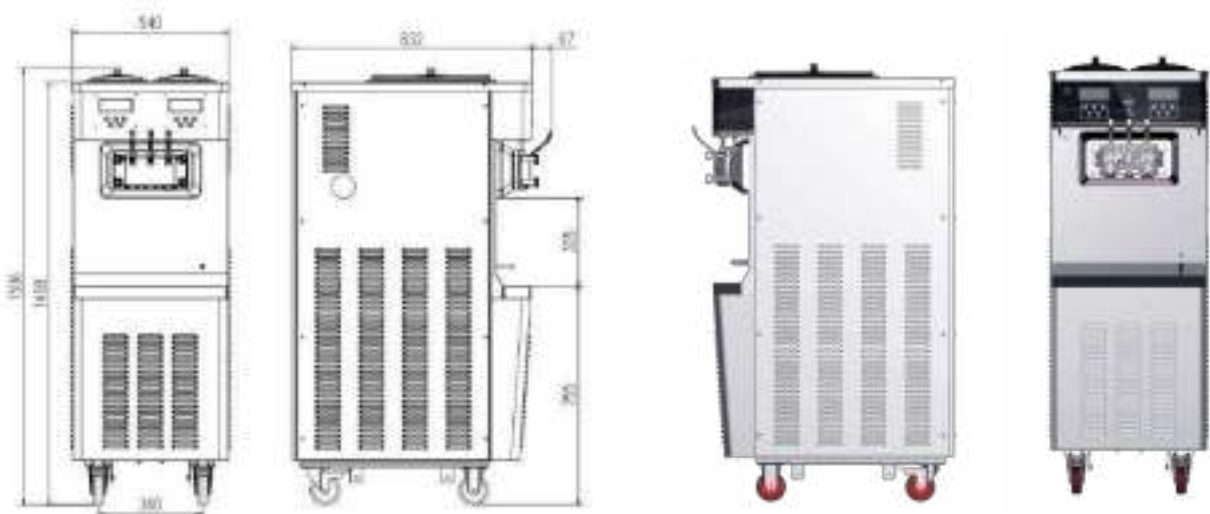

Taycool is never satisfied with a good machine, but the state of perfection.



- Advanced mixing system in hopper, prepare lighter weight, higher overrun, better texture ice cream. Every piece of tiny parts are so precisely and accurately to ensure every detail fits perfectly.



- Perfect continuity of dispensing technology, creates a smooth, creamy ice cream that replicates the consistency of soft serve.



- Integrated frequency converter reduce energy consumption and noise.









- Polished nuts and transparent discharge door highlight the style of your stores.



- Tecumseh compressor and other components from named producers ensure high performance and long durability.



### Unique Features

- Agitator/Hopper Mixing System 
- Counter 
- Smart Pre-cooling 
- Overnight 
- Low Mix Alarm 
- 6-level Hardness Adjustable 
- Error Code Indication 

Super huge capacity series, application of high-tech core technology to meet customer's diversity demands, Taycool TC582S bring you awesome experience.

Equipped with Taycool's patented core control system, intuitive touchable LCD screen, One-step to make creamy soft serve and frozen yogurt, Perfect continuity of dispensing, it can dispense more than 60 cones one time. With the newest long-time keeping fresh function and frequency mute function, enjoy making delicious ice cream quietly.



### General Parameters

Model	TC582S	Installation	Countertop
Capacity	500cones/H(80g/cone)	Flavor	2+Twist
Hopper/Quantity	14L/2	Cylinder/Quantity	2L/2
Net Weight	225KG	Gross Weight	275KG
Product Dimension	540x832x1458 mm	Packing Dimension	650x940x1680 mm

Note: The capacity depends on the operating environment and mixture.

### Electrical Specification

Rated Power	4000W	Voltage/Frequency	220V/50Hz/60Hz
Motor/Quantity	750W/2	Suggested Power Supply	25A

### Refrigeration System

Compressor/Quantity	Tecumseh 1.5HP/2	Refrigerating Capacity	5473x2 BTU/H
Refrigerant	R404a	Cooling System	Air Cooling

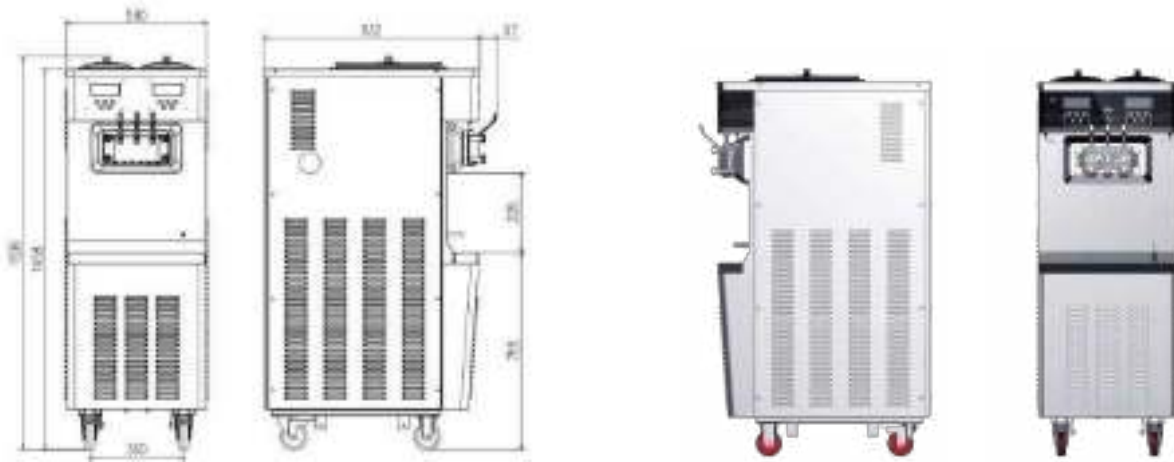

Taycool is never satisfied with a good machine, but the state of perfection.



- Advanced mixing system in hopper, prepare lighter weight, higher overrun, better texture ice cream. Every piece of tiny parts are so precisely and accurately to ensure every detail fits perfectly.



- Perfect continuity of dispensing technology, creates a smooth, creamy ice cream that replicates the consistency of soft serve.



- Integrated frequency converter reduce energy consumption and noise.



- Polished nuts and transparent discharge door highlight the style of your stores.



- Tecumseh compressor and other components from named producers ensure high performance and long durability.